

State of Kansas, Sumner County SS:
Filed for record on the 20th Day of
July, 2012 A.D. at 8:00
o'clock P.M. and recorded in photo
Book 960 at page 353
fees \$124.00
Jessica D. Anderson
Jessica D. Anderson

STATE OF KANSAS
COUNTY OF SUMNER

Line: U
TRACTS: 14353, 14357
14381, 14334
14383, 14344
14377, 14319

ENCROACHMENT AGREEMENT

THIS AGREEMENT, entered into by and between **SOUTHERN STAR CENTRAL GAS PIPELINE, INC.**, a Delaware corporation (formerly Williams Gas Pipelines Central, Inc., Williams Natural Gas Company, Northwest Central Pipeline Corporation and Cities Service Gas Company), with its principal place of business at 4700 Highway 56, and Post Office Box 20010, Owensboro, Kentucky 42301 and 42304 respectively, hereinafter referred to as "GRANTOR" and **EDF RENEWABLE DEVELOPMENT INC.**, 15445 Innovation Drive, San Diego, CA 92128, hereinafter referred to as "GRANTEE",

WITNESSETH:

WHEREAS, GRANTOR is the owner of One (1) twenty inch (20") natural gas pipeline and easements defined as 66' wide with pipeline centered on easement, therefore across the following land to wit:

Section Thirty-Four (34), Township Thirty-Three (33) South, Range One (1) East, and Section Two (2) Three (3), Township Thirty-Four (34) South, Range One (1) East, all in Sumner County, KANSAS.

WHEREAS, GRANTEE owns a valid Lease, according to that certain Assignment of Lease and Easement Agreements, over the following described tracts of land, the "Properties" :

EDF Renewable - Southern Star Encroachment Agreement

RETURN: Southern Star Central Gas Pipeline Inc., P.O. Box 20010, Owensboro, KY 42304

Section Thirty-Four (34), Township Thirty-Three (33) South, Range One (1) East, and Section Two (2) Three (3), Township Thirty-Four (34) South, Range One (1) East, all in Sumner County, KANSAS.

WHEREAS, GRANTEE proposes to develop said properties by building a wind farm for electric power generation on the properties and constructing private roadways, wind turbines, underground collector power lines and overhead transmission lines, as shown on drawings Slate Creek Wind Project, titled Gas Line Crossings Exhibit, prepared by Westwood Professional Services all of which will cross the GRANTOR'S pipelines and easement, in such a manner as to conflict, interfere with, and encroach upon, GRANTOR'S pipelines and easements, and

WHEREAS, GRANTEE has requested that GRANTOR allow temporary bridge crossings of its natural gas pipelines, at designated crossings only, to permit the hauling of materials and equipment, including a crane necessary for the construction of the wind farm across a private roadway to be built over the pipelines and its encroachment on GRANTOR'S pipeline and easement, and

NOW, THEREFORE, in consideration of the premises and the mutual promises of the parties, GRANTOR and GRANTEE agree as follows:

Prior to the construction, GRANTEE will provide plan/profile drawings for all crossings, including temporary roads, permanent roads, electric transmission lines, and all other encroachments across GRANTOR'S easement. GRANTEE shall not commence construction of the GRANTEE facilities within a crossing unless and until it receives GRANTOR's written approval. Under the terms of this Agreement, GRANTOR will request installation of "engineered approved" temporary bridges over the pipeline for equipment that exceeds wheel load analysis GRANTEE agrees to restrict traffic to only the designated crossings shown on GRANTEE'S exhibit, titled Gas Line Crossings Exhibit dated 3-24-2015. Crane crossing will be allowed at crossing #14 and #18, by engineered approved air bridge designed by GRANTOR, titled Pipeline Encroachment Temporary Bridge Crossing Plan and Section, drawing # SK-04-22-2015 attached hereto and made a part hereof. GRANTEE agrees to pothole, all encroachment crossings and provide GRANTOR depths. GRANTEE agrees to provide GRANTOR a list of equipment to perform wheel load analysis ("WLA") calculations on the pipeline. GRANTORS will restrict construction machinery to that equipment which has previously been approved by the WLA and listed on Exhibit A, attached hereto and made a part hereof. GRANTOR reserves the right to revise crossings if additional equipment not listed on Exhibit A is required. Revised equipment list will be sent for review to Southern Star Central Gas Pipeline, Attn: Land Dept., 9120 S. Meridian Street, Haysville, Kansas 67060 or by email to Andrew.D.Buchanan@sscgp.com. GRANTEE agrees no cover will be removed over the pipeline and no permanent above grade structures on GRANTOR'S easement

1. GRANTOR agrees to the encroachment, by GRANTEE, of permanent roadways across GRANTOR'S pipeline easements, at approximately a ninety degree (90°) angle, and crossings will be marked and defined for construction. GRANTEE is liable for any unauthorized crossings that have not been reviewed by GRANTOR. It is understood and agreed that the GRANTEE'S roadways will be constructed so that no portion of any roadway which parallels the pipelines will be within thirty-three (33) feet of the

GRANTOR'S nearest pipeline, except where the roadway crosses the pipelines as shown on Standard Drawings STD-ENC-X-RD or STD-ENC-X-RDSC crossing exhibits all of which are attached hereto and made a part hereof.

2. GRANTEE agrees collector lines may be installed by boring across the pipeline right-of-ways in accordance with Standard Drawings STD-ENC-X-BU. Grantee will provide bore pits during crossing to verify sufficient clearance of the boring tool. It is understood and agreed that the collector lines installations shall be in accordance with GRANTOR'S Standard Drawings STD-ENC-P-OPL or STD-ENC-P-UPL, and GRANTEE'S crossing exhibit, Slate Creek Wind Project, titled Collection System Pipeline Crossing Details, drawing # SLC-EC-215, all of which are attached hereto and made a part hereof.
3. GRANTEE shall notify GRANTOR at least forty-eight (48) hours prior to commencing work on GRANTOR'S easement and shall utilize the Kansas One-Call System at 811.
4. Grantee acknowledges that the natural gas pipeline is cathodically protected and hereby relieves GRANTOR of any liability for damage to any encroachment, structure, that currently exist, or that may exist in the future, due to said cathodic protection and migration of interference issues. GRANTEE agrees to coordinate such cathodic protection with GRANTOR'S Pipeline in a mutually agreeable procedure if bonding or other measures are needed to protect GRANTEE'S equipment.
5. In the event, during the exercise of its easement rights to construct, operate and maintain the pipelines and appurtenances, GRANTOR or its contractors destroy or damage the encroachments herein permitted, all such damages to said permitted items shall be the sole responsibility of GRANTEE except to the extent of GRANTOR'S negligence in such action.
6. GRANTEE agrees to indemnify, save and hold GRANTOR, its parent and affiliates and the employees, officers, directors and agents thereof, harmless from and against any loss, cost or expense incurred by GRANTOR, including without limitation losses resulting from claims for damages to property or injuries to or deaths of persons, judgments, court costs and attorneys' fees which arise out of, or are claimed to have arisen out of, the construction, maintenance or other operations of GRANTEE, its contractors and subcontractors, on the GRANTOR easement, except to the extent such loss, cost or expense is caused by GRANTOR, its contractor's and/or subcontractors.
7. In the event it shall become necessary for either party to commence litigation to enforce any provision of this Agreement, the prevailing party shall be entitled to recover its reasonable attorney's fees and attendant expenses in conjunction with such litigation.
8. Prior to commencement of construction of the above reference work, GRANTEE'S Contractor shall provide GRANTOR proof of self-insurance and its ability to self-insure in the amount of one million dollars (\$1,000,000) general liability, one million dollars (\$1,000,000) auto liability, and one million dollars (\$1,000,000) workers compensation and employers liability insurance, and containing thirty (30) days prior written notice of cancellation.

9. Remedies. Time is of the essence of each provision of this Agreement. In the event of any breach or default of any covenant or agreement under this Agreement, or in the event of the failure or falsity of any representation or warranty made hereunder, the remedies available to the non-breaching or non-defaulting party shall be, exclusively, specific performance, injunctive relief, or the payment of damages attributable thereto or arising therefrom.
10. Term. The term of this Agreement extends for so long as GRANTOR'S or GRANTEE'S easements exist in any form.
11. Notices. All notices given or permitted to be given hereunder shall be in writing. Notice is considered given either (i) when delivered in person to the recipient named below, (ii) upon receipt after deposit in the United States mail in a sealed envelope or container, postage and postal charges prepaid, return receipt requested or certified mail, addressed by name and address to the Party or person intended, or (iii) twenty-four (24) hours from proper and timely delivery to an overnight courier service addressed by name and address to the party or person intended as follows:

Notice to GRANTOR:
Southern Star Central Gas Pipeline Inc.
4700 Highway 56
PO Box 20010
Owensboro, KY 42304
Attention: Land Department

Notice to GRANTEE:
EDF RD
15445 Innovation Drive
San Diego, California 92128
Attention: Land and Title Administration

Either party may, by notice given at any time or from time to time, require subsequent notices to be given to another individual person, whether a party or an officer or representative, or to a different address, or both. Notices given before actual receipt or notice of change shall not be invalidated by the change.

The terms of this Agreement shall constitute covenants running with the land and shall be binding upon and inure to the benefit of the parties hereto, or their successors and assigns. The obligations of the Parties herein shall survive the termination of this Agreement.

IN WITNESS WHEREOF, we hereunto set our hands and seals on the day and year below our signatures indicated.

GRANTEE: EDF Renewable Development Inc.

By: 

Ryan Pfaff
Executive Vice President, Development

Date: July 02, 2015

GRANTOR: ~~EDF~~
SOUTHERN STAR CENTRAL GAS PIPELINE, INC.

By: 

Robert S. Bahnick,
Vice President and Chief Operations Officer

Date: 7/10/15

Signature Page

ACKNOWLEDGEMENT

A notary public or other officer completing this certificate verifies only the identity of the individual who signed the document to which this certificate is attached, and not the truthfulness, accuracy, or validity of that document.

STATE OF CALIFORNIA)
) ss.
COUNTY OF SAN DIEGO)

On _____, 2015, before me, _____, a Notary Public, personally appeared Ryan Pfaff, who proved to me on the basis of satisfactory evidence to be the person whose name is subscribed to the within instrument and acknowledged to me that he executed the same in his authorized capacity, and that by his signature on the instrument the person, or the entity upon behalf of which the person acted, executed the instrument.

I certify under PENALTY OF PERJURY under the laws of the State of California that the foregoing paragraph is true and correct.

WITNESS my hand and official seal.

See Attached Certificate

Notary's Signature

[Notarial Seal]

ACKNOWLEDGEMENT FOR CORPORATION

STATE OF KENTUCKY)
) ss
COUNTY OF DAVIESS)

Before me, the undersigned, a Notary Public duly commissioned in and for the county and state aforesaid, on this 10th day of July, 2015 personally appeared Robert S. Bahnick, who being by me duly sworn, did say that he is Vice President and Chief Operations Officer of Southern Star Central Gas Pipeline, Inc., a Delaware corporation, and that said instrument was signed on behalf of said corporation by authority of its Board of Directors, and said Robert S. Bahnick acknowledged said instrument to be the free act and deed of said corporation.

In testimony whereof, I have hereunto set my hand and affixed my official seal at my office in said county and state the day and year last above written.

ROBIN L. CARLISLE
Notary Public
State at Large, Kentucky
Certificate ID 481488
My Appt Expires: 9-16-15

Robin L. Carlisle
Notary Public

My Commission Expires: September 16, 2015

A notary public or other officer completing this certificate verifies only the identity of the individual who signed the document to which this certificate is attached, and not the truthfulness, accuracy, or validity of that document.

STATE OF CALIFORNIA)
) ss.
COUNTY OF SAN DIEGO)

On July 02, 2015, before me, Susie Yee Stricklin, a Notary Public, personally appeared Ryan Pfaff, who proved to me on the basis of satisfactory evidence to be the person whose name is subscribed to the within instrument and acknowledged to me that he executed the same in his authorized capacity, and that by his signature on the instrument the person, or the entity upon behalf of which the person acted, executed the instrument.

I certify under PENALTY OF PERJURY under the laws of the State of California that the foregoing paragraph is true and correct.

WITNESS my hand and official seal.

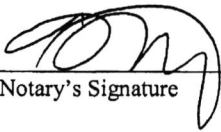

Notary's Signature



[Notarial Seal]

© 2013 Westland Professional Services, Inc.

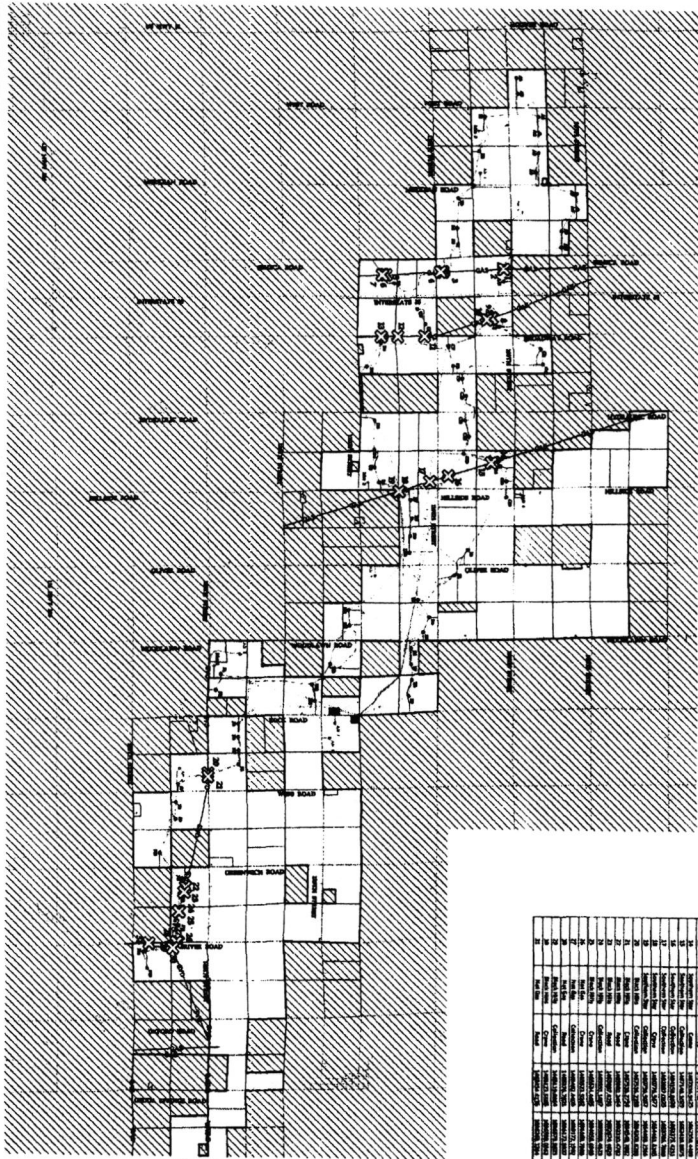

- LEGEND**
- TOWER LOCATION
 - TOWER FOUNDATION
 - ▭ TOWER SUPPORT LOCATION
 - ▬ 10' TOWER
 - ▬ 20' TOWER
 - ▬ 30' TOWER
 - ▬ 40' TOWER
 - ▬ 50' TOWER
 - ▬ 60' TOWER
 - ▬ 70' TOWER
 - ▬ 80' TOWER
 - ▬ 90' TOWER
 - ▬ 100' TOWER
 - ▬ 110' TOWER
 - ▬ 120' TOWER
 - ▬ 130' TOWER
 - ▬ 140' TOWER
 - ▬ 150' TOWER
 - ▬ 160' TOWER
 - ▬ 170' TOWER
 - ▬ 180' TOWER
 - ▬ 190' TOWER
 - ▬ 200' TOWER
 - ▬ 210' TOWER
 - ▬ 220' TOWER
 - ▬ 230' TOWER
 - ▬ 240' TOWER
 - ▬ 250' TOWER
 - ▬ 260' TOWER
 - ▬ 270' TOWER
 - ▬ 280' TOWER
 - ▬ 290' TOWER
 - ▬ 300' TOWER
 - ▬ 310' TOWER
 - ▬ 320' TOWER
 - ▬ 330' TOWER
 - ▬ 340' TOWER
 - ▬ 350' TOWER
 - ▬ 360' TOWER
 - ▬ 370' TOWER
 - ▬ 380' TOWER
 - ▬ 390' TOWER
 - ▬ 400' TOWER
 - ▬ 410' TOWER
 - ▬ 420' TOWER
 - ▬ 430' TOWER
 - ▬ 440' TOWER
 - ▬ 450' TOWER
 - ▬ 460' TOWER
 - ▬ 470' TOWER
 - ▬ 480' TOWER
 - ▬ 490' TOWER
 - ▬ 500' TOWER
 - ▬ 510' TOWER
 - ▬ 520' TOWER
 - ▬ 530' TOWER
 - ▬ 540' TOWER
 - ▬ 550' TOWER
 - ▬ 560' TOWER
 - ▬ 570' TOWER
 - ▬ 580' TOWER
 - ▬ 590' TOWER
 - ▬ 600' TOWER
 - ▬ 610' TOWER
 - ▬ 620' TOWER
 - ▬ 630' TOWER
 - ▬ 640' TOWER
 - ▬ 650' TOWER
 - ▬ 660' TOWER
 - ▬ 670' TOWER
 - ▬ 680' TOWER
 - ▬ 690' TOWER
 - ▬ 700' TOWER
 - ▬ 710' TOWER
 - ▬ 720' TOWER
 - ▬ 730' TOWER
 - ▬ 740' TOWER
 - ▬ 750' TOWER
 - ▬ 760' TOWER
 - ▬ 770' TOWER
 - ▬ 780' TOWER
 - ▬ 790' TOWER
 - ▬ 800' TOWER
 - ▬ 810' TOWER
 - ▬ 820' TOWER
 - ▬ 830' TOWER
 - ▬ 840' TOWER
 - ▬ 850' TOWER
 - ▬ 860' TOWER
 - ▬ 870' TOWER
 - ▬ 880' TOWER
 - ▬ 890' TOWER
 - ▬ 900' TOWER
 - ▬ 910' TOWER
 - ▬ 920' TOWER
 - ▬ 930' TOWER
 - ▬ 940' TOWER
 - ▬ 950' TOWER
 - ▬ 960' TOWER
 - ▬ 970' TOWER
 - ▬ 980' TOWER
 - ▬ 990' TOWER
 - ▬ 1000' TOWER

County #	Section	Range	Block	Acres	Owner
1	1	1	1	1.00	...
1	1	1	2	1.00	...
1	1	1	3	1.00	...
1	1	1	4	1.00	...
1	1	1	5	1.00	...
1	1	1	6	1.00	...
1	1	1	7	1.00	...
1	1	1	8	1.00	...
1	1	1	9	1.00	...
1	1	1	10	1.00	...
1	1	1	11	1.00	...
1	1	1	12	1.00	...
1	1	1	13	1.00	...
1	1	1	14	1.00	...
1	1	1	15	1.00	...
1	1	1	16	1.00	...
1	1	1	17	1.00	...
1	1	1	18	1.00	...
1	1	1	19	1.00	...
1	1	1	20	1.00	...
1	1	1	21	1.00	...
1	1	1	22	1.00	...
1	1	1	23	1.00	...
1	1	1	24	1.00	...
1	1	1	25	1.00	...
1	1	1	26	1.00	...
1	1	1	27	1.00	...
1	1	1	28	1.00	...
1	1	1	29	1.00	...
1	1	1	30	1.00	...
1	1	1	31	1.00	...
1	1	1	32	1.00	...
1	1	1	33	1.00	...
1	1	1	34	1.00	...
1	1	1	35	1.00	...
1	1	1	36	1.00	...
1	1	1	37	1.00	...
1	1	1	38	1.00	...
1	1	1	39	1.00	...
1	1	1	40	1.00	...
1	1	1	41	1.00	...
1	1	1	42	1.00	...
1	1	1	43	1.00	...
1	1	1	44	1.00	...
1	1	1	45	1.00	...
1	1	1	46	1.00	...
1	1	1	47	1.00	...
1	1	1	48	1.00	...
1	1	1	49	1.00	...
1	1	1	50	1.00	...
1	1	1	51	1.00	...
1	1	1	52	1.00	...
1	1	1	53	1.00	...
1	1	1	54	1.00	...
1	1	1	55	1.00	...
1	1	1	56	1.00	...
1	1	1	57	1.00	...
1	1	1	58	1.00	...
1	1	1	59	1.00	...
1	1	1	60	1.00	...
1	1	1	61	1.00	...
1	1	1	62	1.00	...
1	1	1	63	1.00	...
1	1	1	64	1.00	...
1	1	1	65	1.00	...
1	1	1	66	1.00	...
1	1	1	67	1.00	...
1	1	1	68	1.00	...
1	1	1	69	1.00	...
1	1	1	70	1.00	...
1	1	1	71	1.00	...
1	1	1	72	1.00	...
1	1	1	73	1.00	...
1	1	1	74	1.00	...
1	1	1	75	1.00	...
1	1	1	76	1.00	...
1	1	1	77	1.00	...
1	1	1	78	1.00	...
1	1	1	79	1.00	...
1	1	1	80	1.00	...
1	1	1	81	1.00	...
1	1	1	82	1.00	...
1	1	1	83	1.00	...
1	1	1	84	1.00	...
1	1	1	85	1.00	...
1	1	1	86	1.00	...
1	1	1	87	1.00	...
1	1	1	88	1.00	...
1	1	1	89	1.00	...
1	1	1	90	1.00	...
1	1	1	91	1.00	...
1	1	1	92	1.00	...
1	1	1	93	1.00	...
1	1	1	94	1.00	...
1	1	1	95	1.00	...
1	1	1	96	1.00	...
1	1	1	97	1.00	...
1	1	1	98	1.00	...
1	1	1	99	1.00	...
1	1	1	100	1.00	...

**Slate Creek
Wind Project**
Sumner County, Kansas

Call Lisa Cawlings
Bathin

NOT FOR CONSTRUCTION

Rev. 8/24/13
Sheet 1 of 1



Mortenson
CONSTRUCTION

GDF
SUSTAINABLE ENERGY

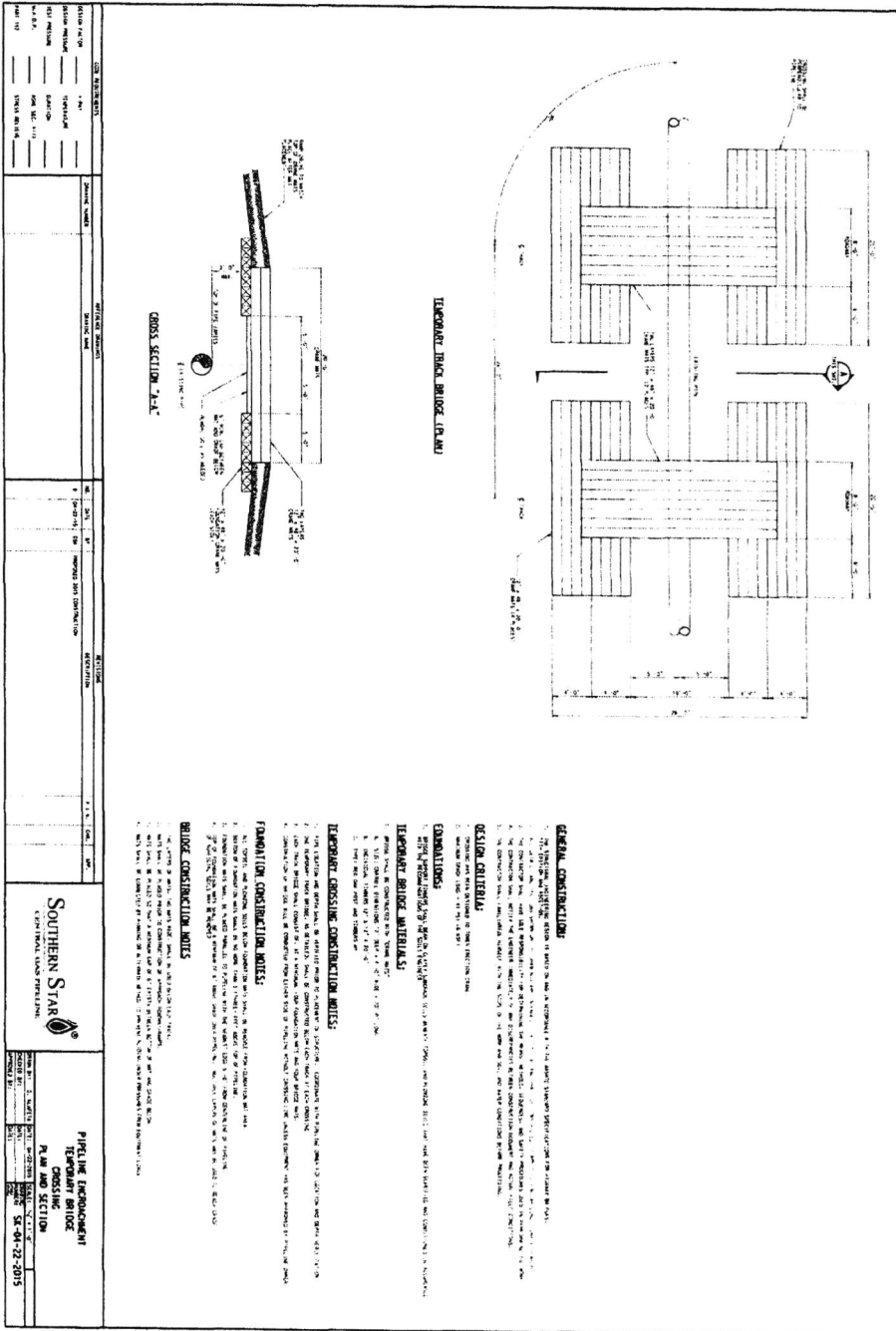
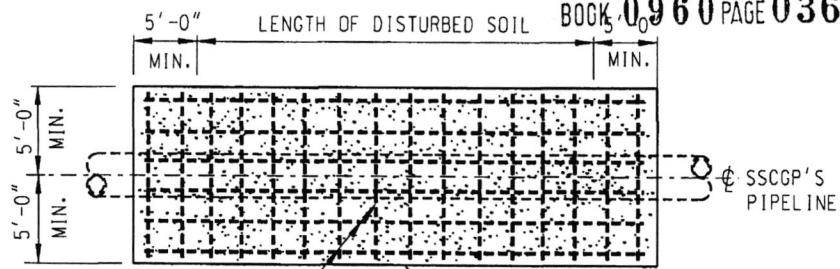

Exhibit A

		Slate Creek Wind Project 14140024	Gas Pipeline Crossings Gas Pipeline Crossings	
Crossing Type	Description	Type	Weight (lbs)	
Over Line Crossing (Crossing #14,18)	Crawler Crane	Manitowoc 16000 wa	931,190	
	Rough Terrain Crane	Grove RT890E	115,976	
	Excavator	349F	117,500	
	Bulldozer	D6T	46,158	
	Grader	140M	43,834	
	Soil Compactor	14M	53,738	
	Soil Compactor	CS56B	25,707	
	Soil Compactor	CS56P	25,346	
Crossing Type	Description	Type	Weights (lbs)	
Underground Crossing (Crossing Number# 15,16,17,19)	Bore Equipment	N/A		20,800





#4 REBAR @ 12" C/C BOTH WAYS

REINFORCED CONCRETE SLAB TO PROTECT PIPELINE WHERE 5'-6" MINIMUM UNDISTURBED COVER IS NOT ATTAINABLE.

SECTION "1-1"

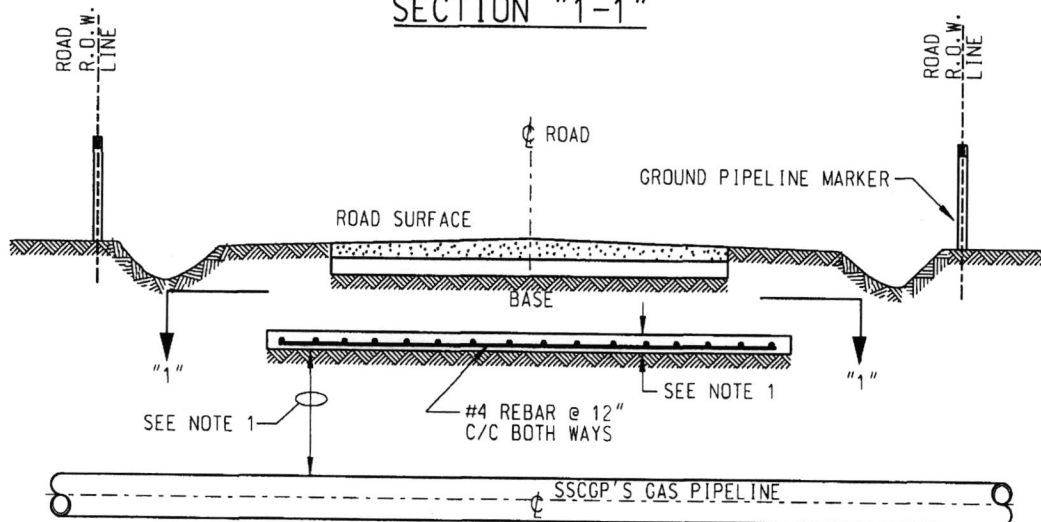

ELEVATION

NOTES:

1. IF 5'-6" UNDISTURBED MINIMUM CLEARANCE CANNOT BE ATTAINED, AS PER DRAWING STD-ENC-X-RD, LESS CLEARANCE MAY BE ALLOWED IF THE PIPELINE IS PROVIDED WITH ADDITIONAL PROTECTION TO WITHSTAND ANTICIPATED EXTERNAL LOADS AS SHOWN ABOVE. THE MINIMUM CLEARANCE AND SLAB THICKNESS MUST BE DETERMINED BY THE SSCGP ENGINEERING DEPARTMENT.

Southern Star
CENTRAL GAS PIPELINE

STANDARD ENCROACHMENT DETAILS
FOR SPECIAL CONSIDERATION ROAD CROSSING

REV.	DATE	BY	DESCRIPTION	APP	SCALE: 1" = 1'-0"
0	05-14-2004	GLS	REPLACES DRAWING 005-079-A-0163	RDH	P. I. N.
1	11-05-2007	JAK	REPLACED STD. DWG. 005-002-A-0210	RDH	DWG. NO.
					STD-ENC-X-RDSC

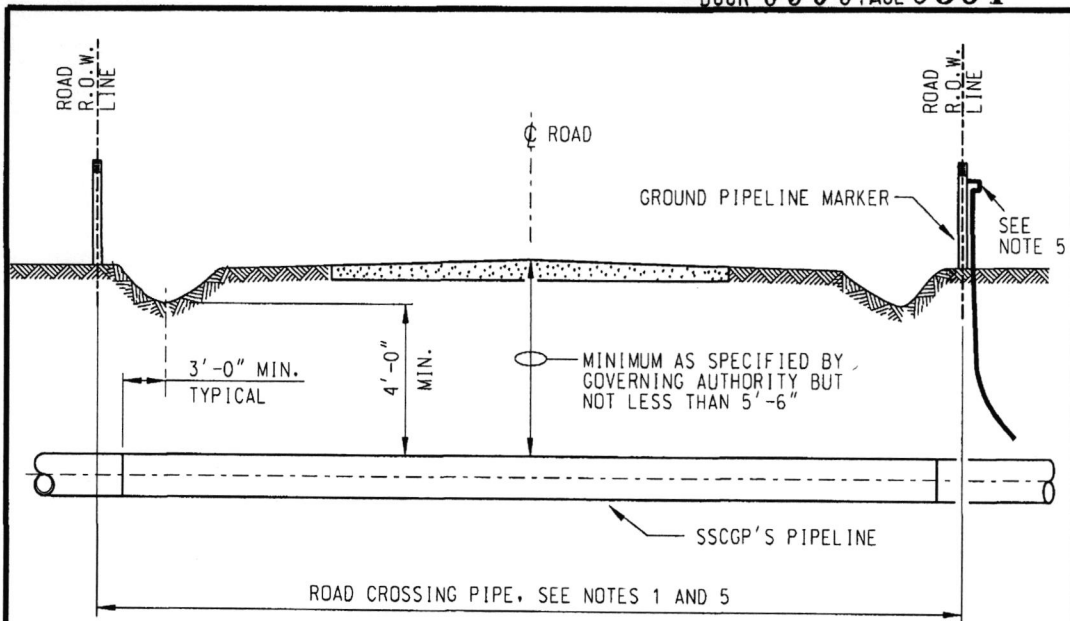

ELEVATION

NOTES:

1. SPECIFICATIONS AND LENGTH OF PIPE FOR CROSSINGS SHALL BE AS SHOWN ON THE SPECIFIC PROFILE DRAWINGS. NO VERTICAL BENDS SHALL BE MADE WITHIN THESE LIMITS.
2. INSTALLATION SHALL BE MADE IN ACCORDANCE WITH APPLICABLE PERMIT.
3. THE TRENCH EXCAVATED FOR THE PIPELINE SHALL BE PROMPTLY BACKFILLED IN A PROPER AND WORKMANLIKE MANNER SO AS TO LEAVE NO VOIDS OR OBSTRUCTIONS THEREIN AND SO AS TO FURNISH AND PROVIDE DRAINAGE.
4. ROAD CROSSING PIPE SHALL EXTEND TO A MINIMUM OF 3' BEYOND TOE OF SLOPE (TYPICAL EACH SIDE). FULL JOINTS OF PIPE SHALL BE USED UNLESS DIRECTED OTHERWISE BY ENGINEER.
5. INSTALL CATHODIC PROTECTION TEST STATION PER STANDARD DRAWING WHERE DESIGNATED BY COMPANY. SEE DRAWING STD-ENC-X-RDSC FOR PIPE CROSSINGS WITH LESS THAN 5'-6" COVER.



STANDARD ENCROACHMENT DETAILS FOR ROAD CROSSING

DRAWN BY: GLS		DATE: 05-05-2004		REV.	DATE	BY	DESCRIPTION	APP	SCALE: 1" = 1'-0"
CHECKED BY:		DATE:		0	05-05-2004	GLS	REVISED PER SSCGP STANDARDS	RDH	P.I.N.
APPROVED BY: RDH		DATE: 05-28-2004		1	11-05-2007	JAK	REPLACED STD. DWG. 005-002-A-0062	RDH	DWG. NO.
									STD-ENC-X-RD

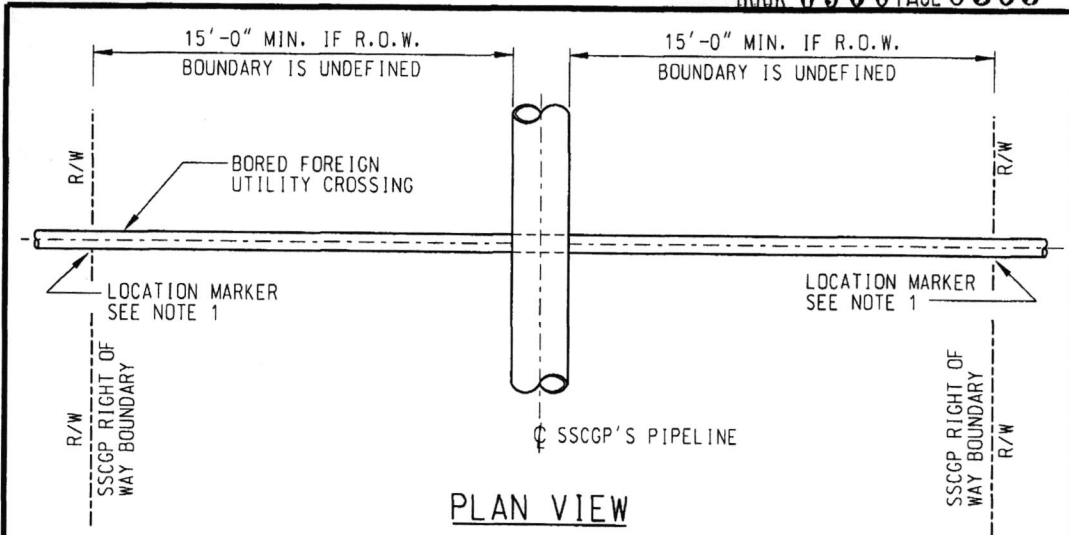

PLAN VIEW

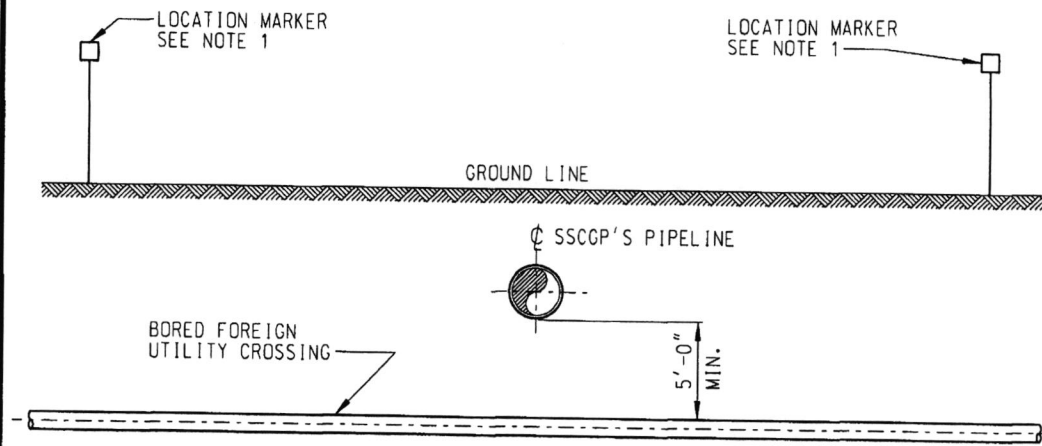

ELEVATION

NOTES:

- 1. ABOVE GROUND UTILITY LOCATION MARKER WILL BE INSTALLED ABOVE CROSSING AT SSCGP ROW BOUNDARY.

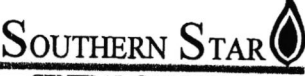
 <p>SOUTHERN STAR CENTRAL GAS PIPELINE</p>		STANDARD ENCROACHMENT DETAILS FOR INSTALLATION OF BORED UTILITY CROSSING BELOW EXISTING GAS PIPELINE					
		REV.	DATE	BY	DESCRIPTION	APP	SCALE: 1" = 1'-0"
DRAWN BY: GLS	DATE: 05-04-2004	0	05-04-2004	GLS	REVISED PER SSCGP STANDARDS	RDH	P.I.N.
CHECKED BY:	DATE:	1	11-05-2007	JAK	REPLACED STD. DWG. 005-090-A-0142	RDH	DWG. NO.
APPROVED BY: RDH	DATE: 05-28-2004						STD-ENC-X-BU

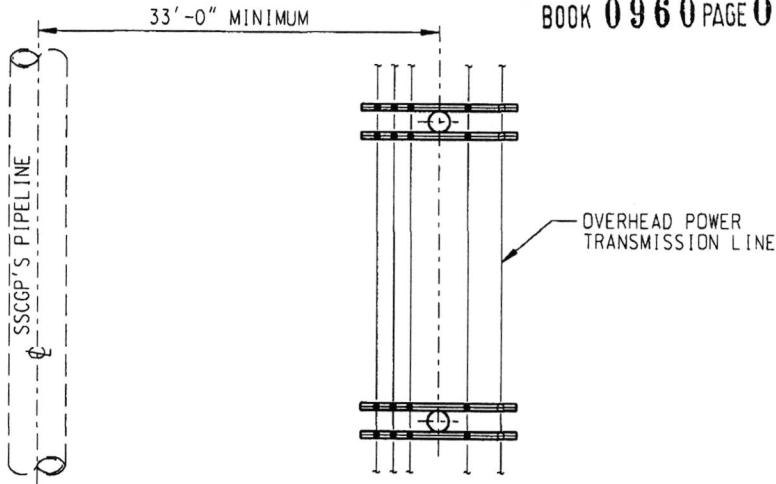

PLAN VIEW

NOTE:
ANNUAL SURVEY OF A-C POTENTIAL
TO BE MADE OF PIPELINE TO INSURE
MAXIMUM OF 20 VOLTS INDUCED
POTENTIAL NOT PRESENT.

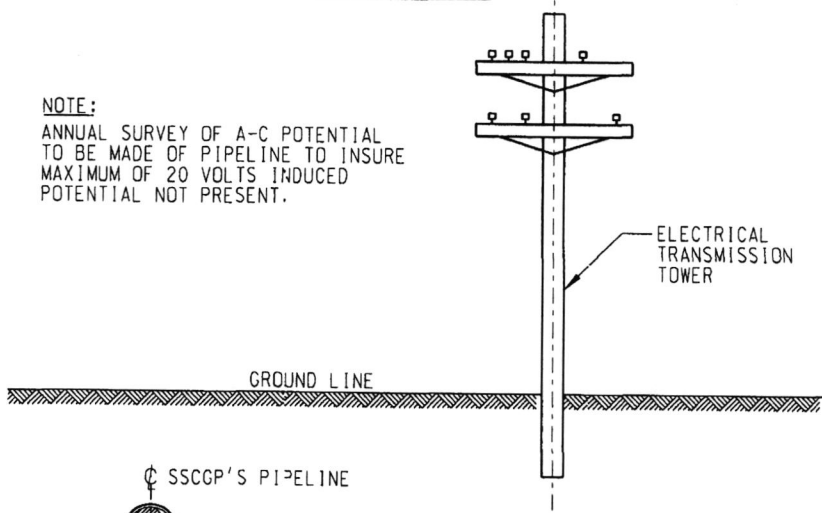

ELEVATION



STANDARD ENCROACHMENT DETAILS
FOR INSTALLATION OF OVERHEAD POWER LINES
PARALLEL TO SSCGP'S PIPELINE

REV.	DATE	BY	DESCRIPTION	APP	SCALE: 1" = 1'-0"
0	05-05-2004	GLS	REVISED PER SSCGP STANDARDS	RDH	P. I. N.
1	11-05-2007	JAK	REPLACED STD. DWG. 005-090-A-0075	RDH	DWG. NO. STD-ENC-P-OPL

DRAWN BY: GLS DATE: 05-05-2004
CHECKED BY: DATE:
APPROVED BY: RDH DATE: 05-28-2004

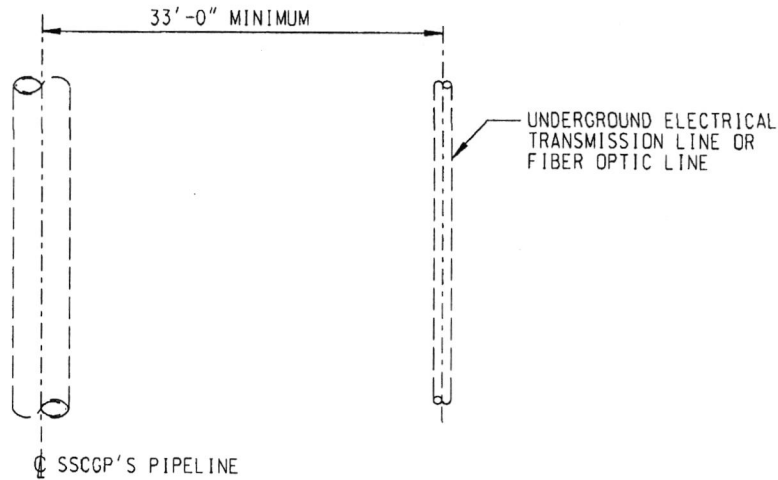

PLAN VIEW

NOTE:

ANNUAL SURVEY OF A-C POTENTIAL TO BE MADE OF PIPELINE TO INSURE MAXIMUM OF 20 VOLTS INDUCED POTENTIAL NOT PRESENT.

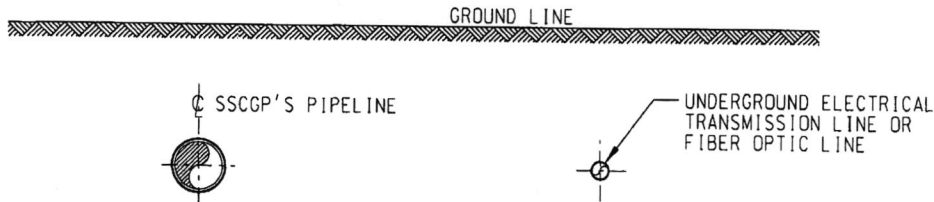

ELEVATION

 SOUTHERN STAR CENTRAL GAS PIPELINE		STANDARD ENCROACHMENT DETAILS FOR INSTALLATION OF UNDERGROUND POWER LINES AND FIBER OPTIC LINES PARALLEL TO SSCGP'S PIPELINE					
		REV.	DATE	BY	DESCRIPTION	APP	SCALE: 1" = 1'-0"
DRAWN BY: GLS	DATE: 05-04-2004	0	05-05-2004	GLS	REVISED PER SSCGP STANDARDS	RDH	P.I.N.
CHECKED BY:	DATE:	1	11-05-2007	JAK	REPLACED STD. DWG. 005-090-A-0076	RDH	DWG. NO.
APPROVED BY: RDH	DATE: 05-28-2004						STD-ENC-P-UPL

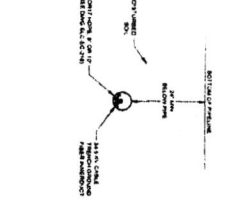

CABLE SIZE	NO. OF CABLES	NO. OF ANCHORS	NO. OF TOWER
1/2" DIA	2	2	1
3/4" DIA	2	2	1
1" DIA	2	2	1
1 1/4" DIA	2	2	1
1 1/2" DIA	2	2	1
1 3/4" DIA	2	2	1
2" DIA	2	2	1
2 1/4" DIA	2	2	1
2 1/2" DIA	2	2	1
2 3/4" DIA	2	2	1
3" DIA	2	2	1

1. PRELIMINARY CROSSING DETAIL - ROSE ROCK

1. THIS DRAWING IS A PRELIMINARY DESIGN AND IS SUBJECT TO CHANGE WITHOUT NOTICE.
2. THE DESIGNER HAS CONDUCTED VISUAL CHECKS OF THE DRAWING FOR CONFORMANCE WITH THE DESIGN CRITERIA.
3. THE DESIGNER HAS CONDUCTED VISUAL CHECKS OF THE DRAWING FOR CONFORMANCE WITH THE DESIGN CRITERIA.
4. THE DESIGNER HAS CONDUCTED VISUAL CHECKS OF THE DRAWING FOR CONFORMANCE WITH THE DESIGN CRITERIA.
5. THE DESIGNER HAS CONDUCTED VISUAL CHECKS OF THE DRAWING FOR CONFORMANCE WITH THE DESIGN CRITERIA.
6. THE DESIGNER HAS CONDUCTED VISUAL CHECKS OF THE DRAWING FOR CONFORMANCE WITH THE DESIGN CRITERIA.
7. THE DESIGNER HAS CONDUCTED VISUAL CHECKS OF THE DRAWING FOR CONFORMANCE WITH THE DESIGN CRITERIA.
8. THE DESIGNER HAS CONDUCTED VISUAL CHECKS OF THE DRAWING FOR CONFORMANCE WITH THE DESIGN CRITERIA.
9. THE DESIGNER HAS CONDUCTED VISUAL CHECKS OF THE DRAWING FOR CONFORMANCE WITH THE DESIGN CRITERIA.
10. THE DESIGNER HAS CONDUCTED VISUAL CHECKS OF THE DRAWING FOR CONFORMANCE WITH THE DESIGN CRITERIA.
11. THE DESIGNER HAS CONDUCTED VISUAL CHECKS OF THE DRAWING FOR CONFORMANCE WITH THE DESIGN CRITERIA.

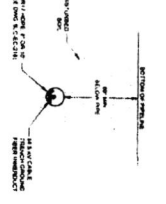

CABLE SIZE	NO. OF CABLES	NO. OF ANCHORS	NO. OF TOWER
1/2" DIA	2	2	1
3/4" DIA	2	2	1
1" DIA	2	2	1
1 1/4" DIA	2	2	1
1 1/2" DIA	2	2	1
1 3/4" DIA	2	2	1
2" DIA	2	2	1
2 1/4" DIA	2	2	1
2 1/2" DIA	2	2	1
2 3/4" DIA	2	2	1
3" DIA	2	2	1

2. PRELIMINARY CROSSING DETAIL - SOUTHERN STAR

1. THIS DRAWING IS A PRELIMINARY DESIGN AND IS SUBJECT TO CHANGE WITHOUT NOTICE.
2. THE DESIGNER HAS CONDUCTED VISUAL CHECKS OF THE DRAWING FOR CONFORMANCE WITH THE DESIGN CRITERIA.
3. THE DESIGNER HAS CONDUCTED VISUAL CHECKS OF THE DRAWING FOR CONFORMANCE WITH THE DESIGN CRITERIA.
4. THE DESIGNER HAS CONDUCTED VISUAL CHECKS OF THE DRAWING FOR CONFORMANCE WITH THE DESIGN CRITERIA.
5. THE DESIGNER HAS CONDUCTED VISUAL CHECKS OF THE DRAWING FOR CONFORMANCE WITH THE DESIGN CRITERIA.
6. THE DESIGNER HAS CONDUCTED VISUAL CHECKS OF THE DRAWING FOR CONFORMANCE WITH THE DESIGN CRITERIA.
7. THE DESIGNER HAS CONDUCTED VISUAL CHECKS OF THE DRAWING FOR CONFORMANCE WITH THE DESIGN CRITERIA.
8. THE DESIGNER HAS CONDUCTED VISUAL CHECKS OF THE DRAWING FOR CONFORMANCE WITH THE DESIGN CRITERIA.
9. THE DESIGNER HAS CONDUCTED VISUAL CHECKS OF THE DRAWING FOR CONFORMANCE WITH THE DESIGN CRITERIA.
10. THE DESIGNER HAS CONDUCTED VISUAL CHECKS OF THE DRAWING FOR CONFORMANCE WITH THE DESIGN CRITERIA.
11. THE DESIGNER HAS CONDUCTED VISUAL CHECKS OF THE DRAWING FOR CONFORMANCE WITH THE DESIGN CRITERIA.

HOLD - TO BE PROVIDED ONCE REQUIREMENTS ARE RECEIVED

PIPELINE CROSSING DETAIL - BLACK HILLS & MOUNTAIN



FOR CONSTRUCTION

Mortenson
construction

Utberg
Engineering & Construction

edf
renewable energy

DATE: 03/12/15

SCALE: NONE

DRAWN BY: JG

CHECKED BY: JG

APPROVED BY: JG

PROJECT #: 14140024

DESCRIPTION: PIPELINE CROSSING DETAILS

COLLECTION SYSTEM

PIPELINE CROSSING DETAILS

SLATE CREEK WIND PROJECT

OWNER: Slatemore & Company, Kansas

DWG. NO.: SL-C-EC-215

REV. NO.: 0